

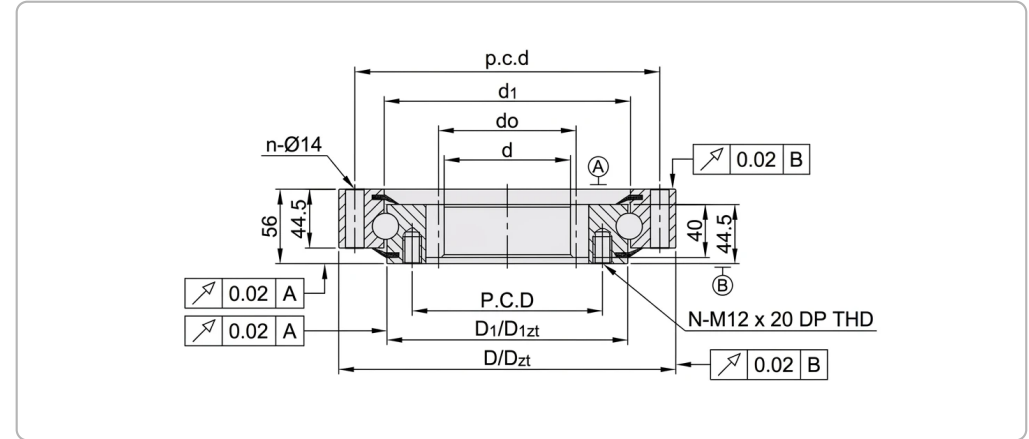

Product View



Section Drawing

Technical Parameters

Parameter	Value
Contact Type	4-Point Contact
Gear Type	Internal Gear Type
Precision Class	P5
Sealing	Rubber seals on both sides
Material	SUJ2 (GCr15)
Operating temperature	-20°C to +80°C
Running Accuracy	Radial & Axial Run-out <= 0.02 mm
Raceway Hardness	58-62 HRC
Bore Diameter (d)	325 mm
Height (H)	56 mm
Outside Diameter (D)	486 mm
Outside diameter tolerance	-0.5mm to 0
Width outer ring (ha)	44.5 mm
Width inner ring (hi)	44.5 mm
Width gearing (b)	40 mm
Outer Ring Pilot Diameter (Dzt)	484 mm
Inner diameter outer ring (d1)	415.5 mm
Inner diameter outer ring tolerance	0.5mm to 0
Outside diameter inner ring (D1)	412.5 mm

Parameter	Value
Outside diameter inner ring tolerance	-0.5mm to 0
Inner Ring Pilot (D1zt)	411 mm
Pitch circle diameter gearing (do)	335 mm
Module of gearing (M)	5 mm
Number of teeth (Z)	67
Pressure Angle	20°
Pitchcircle diameter fixing holes outer ring (p.c.d)	460 mm
Number of fixing holes in outer ring (n)	24
Fixing bore	14 mm
Pitchcircle diameter fixing holes inner ring (P.C.D)	375 mm
Number of fixing holes in inner ring (n)	24
Threaded fixing bore	M12
Thread depth fixing hole	20 mm
Basic dynamic load rating, axial (Ca)	169 KN
Basic static load rating, axial (C0a)	560 KN
Basic dynamic load rating, radial (Cr)	111 KN
Basic static load rating, radial (C0r)	248 KN
Radial Clearance	0-0.05 mm
Axial Clearance	0-0.08 mm