

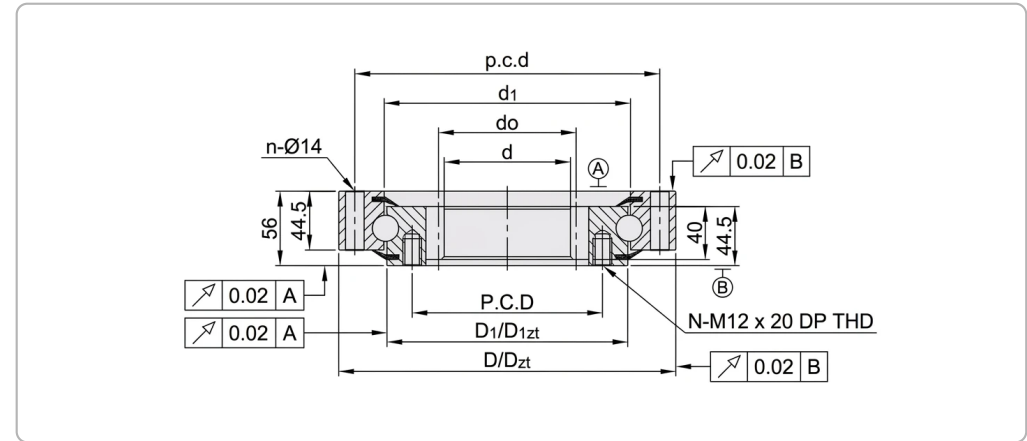

Product View



Section Drawing

Technical Parameters

Parameter	Value
Contact Type	4-Point Contact
Gear Type	External Gear Type
Precision Class	P5
Sealing	Rubber seals on both sides
Material	SUJ2 (GCr15)
Operating temperature	-20°C to +80°C
Running Accuracy	Radial & Axial Run-out ≤ 0.02 mm
Raceway Hardness	58-62 HRC
Bore Diameter (d)	872 mm
Bore Diameter tolerance	0.7mm to 0
Height (H)	56 mm
Outside Diameter (D)	1046.1 mm
Width outer ring (ha)	44.5 mm
Width inner ring (hi)	44.5 mm
Width gearing (b)	40 mm
Outer Ring Pilot Diameter (Dzt)	874 mm
Inner diameter outer ring (d1)	945.5 mm
Inner diameter outer ring tolerance	0.7mm to 0
Outside diameter inner ring (D1)	942.5 mm

Parameter	Value
Outside diameter inner ring tolerance	0.7mm to 0
Inner Ring Pilot (D1zt)	947 mm
Pitch circle diameter gearing (do)	1032 mm
Module of gearing (M)	8 mm
Number of teeth (Z)	129
Pressure Angle	20°
Pitchcircle diameter fixing holes outer ring (p.c.d)	985 mm
Number of fixing holes in outer ring (n)	40
Fixing bore	14 mm
Pitchcircle diameter fixing holes inner ring (P.C.D)	898 mm
Number of fixing holes in inner ring (n)	44
Threaded fixing bore	M12
Thread depth fixing hole	20 mm
Basic dynamic load rating, axial (Ca)	231 KN
Basic static load rating, axial (C0a)	1280 KN
Basic dynamic load rating, radial (Cr)	151 KN
Basic static load rating, radial (C0r)	570 KN
Radial Clearance	0-0.05 mm
Axial Clearance	0-0.08 mm